

# リミットロード送風機LS型寸法表

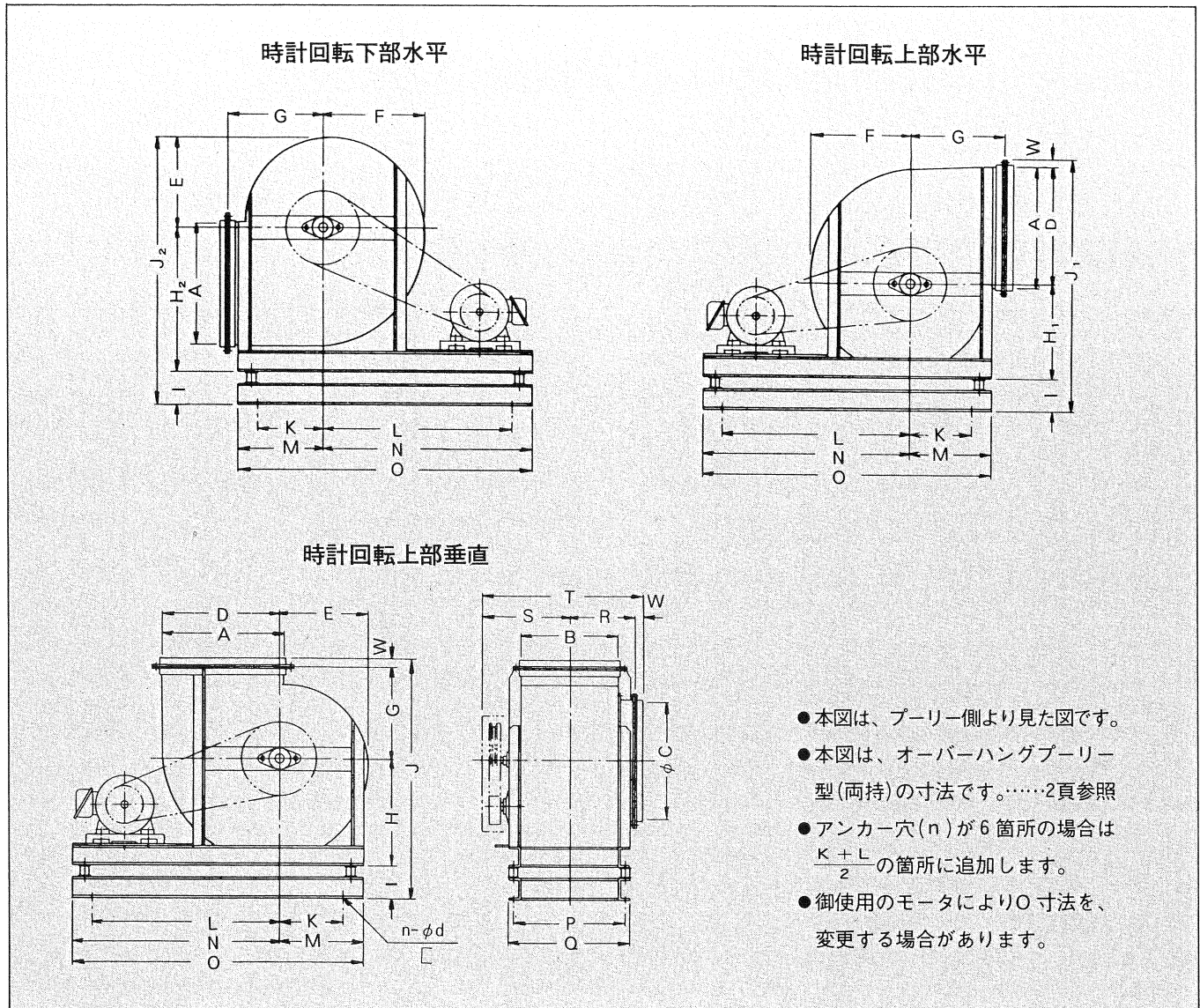

- 本図は、プーリー側より見た図です。
- 本図は、オーバーハングプーリー型(両持)の寸法です。……2頁参照
- アンカー穴(n)が6箇所の場合は  $\frac{K+L}{2}$  の箇所に追加します。
- 御使用のモータによりO寸法を、変更する場合があります。

(単位: mm) ●モータ重量表

型番	A	B	φC	D	E	F	G	H	H <sub>1</sub>	H <sub>2</sub>	I	J	J <sub>1</sub>	J <sub>2</sub>	K	L	M	N	O	P	Q	R	S	T	W	n-φd	□	重量(kg)		出力(kw)		重量(kg)
																												本体	架台	4極	6極	
# 2	315	245	336	300	225	257	270	270	240	360	105	675	630	690	160	580	240	660	900	290	325	183	260	473	30	4-12	80×40	71	7.0	0.4	—	10.5
2 ½	390	315	405	375	282	322	320	335	300	435	120	805	825	837	200	660	280	740	1020	360	395	218	300	548	30	4-12	80×40	94	8.0	0.75	—	14.2
3	467	355	480	450	337	385	360	410	365	550	120	920	965	1007	220	760	320	860	1180	400	435	238	325	593	30	4-15	80×40	134	9.0	2.2	1.5	35.2
3 ½	543	440	560	525	394	450	400	475	420	625	120	1025	1095	1139	260	820	360	920	1280	485	520	280	385	695	30	4-15	80×40	185	10.0	3.7	2.2	43
4	620	500	670	600	446	510	465	535	470	710	120	1150	1220	1276	325	975	425	1075	1500	545	580	310	435	775	30	6-15	80×40	240	11.5	5.5	3.7	70
4 ½	695	555	760	675	502	574	520	600	530	785	120	1270	1355	1407	375	1025	475	1125	1600	600	635	338	465	833	30	6-15	80×40	307	12.5	7.5	5.5	85
5	780	600	840	760	558	638	585	665	585	890	140	1430	1525	1588	430	1170	530	1270	1800	655	700	380	495	915	40	6-15	100×50	390	24	11	7.5	115
5 ½	850	680	900	825	613	701	615	730	645	955	140	1525	1650	1708	460	1290	560	1390	1950	735	880	420	540	1000	40	6-15	100×50	523	26	18.5	—	191
6	925	745	1010	900	669	765	670	795	700	1030	140	1645	1780	1839	515	1335	615	1435	2050	800	845	453	600	1093	40	6-15	100×50	605	28	22	15	211
7	1120	900	1200	1070	781	893	830	930	810	1230	175	1985	2105	2186	600	1480	750	1630	2380	970	1030	553	635	1238	50	6-18	125×65	918	92	30	18.5	271
8	1240	995	1350	1210	892	1020	875	1050	920	1370	175	2150	2355	2437	660	1540	810	1690	2500	1065	1125	598	690	1338	50	6-18	125×65	1200	97	37	30	271
9	1375	1110	1530	1340	1004	1148	1020	1190	1035	1540	200	2475	2640	2744	780	1770	930	1920	2850	1190	1260	685	745	1495	65	6-18	150×75	1715	153	45	37	296
10	1520	1200	1700	1500	1115	1275	1120	1310	1160	1700	200	2695	2925	3015	880	1970	1030	2120	3150	1280	1350	735	820	1620	65	6-18	150×75	2167	167	55	45	350
11	1680	1340	1880	1640	1232	1408	1210	1500	1320	1840	200	2975	3225	3272	960	2090	1110	2240	3350	1420	1490	827	890	1782	65	6-18	150×75	2457	180	75	55	470
12	1850	1480	2040	1810	1362	1554	1320	1650	1450	2010	200	3235	3525	3572	970	2230	1220	2380	3600	1560	1630	897	960	1922	65	6-18	150×75	3550	195	—	—	—

※重量はモーターベースを含んだ値です。

# 選定図

## リミットロード送風機片吸込LS型

### #2LS

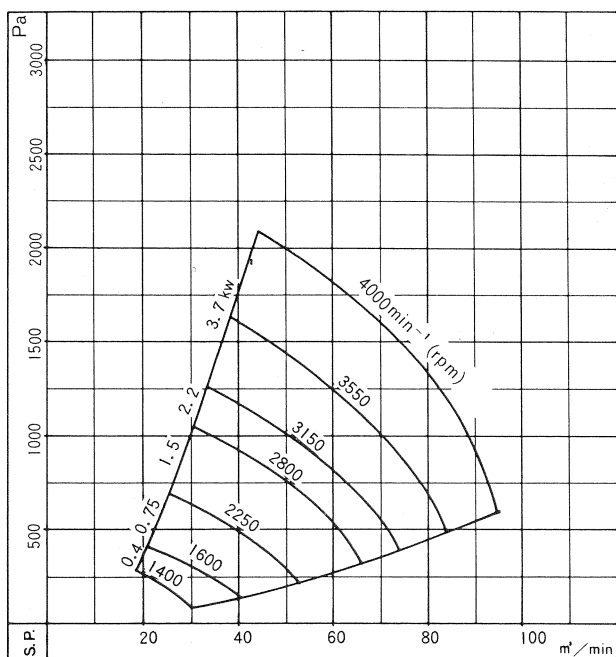

### #2 1/2LS

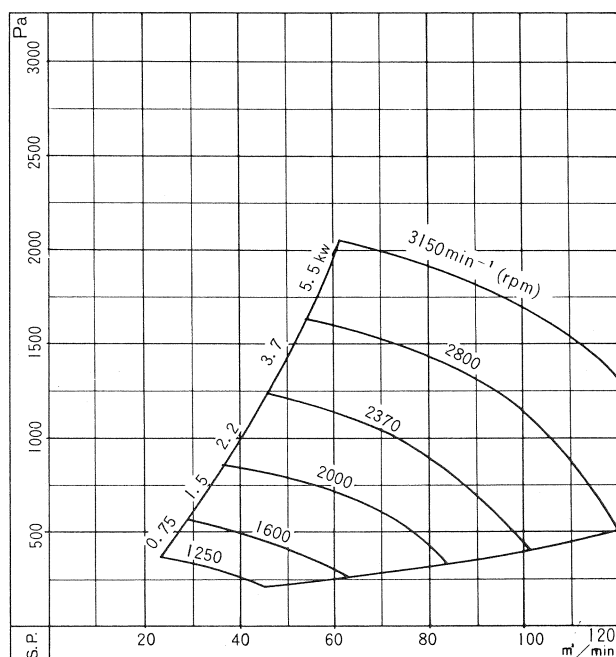

### #3LS

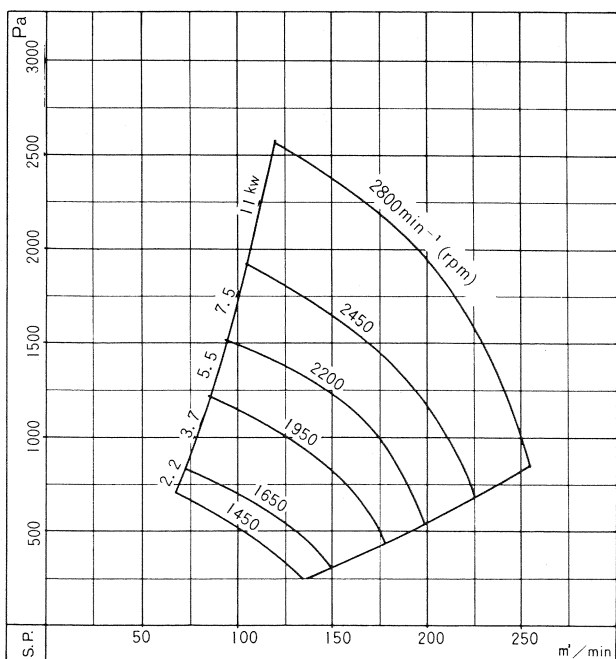

### #3 1/2LS

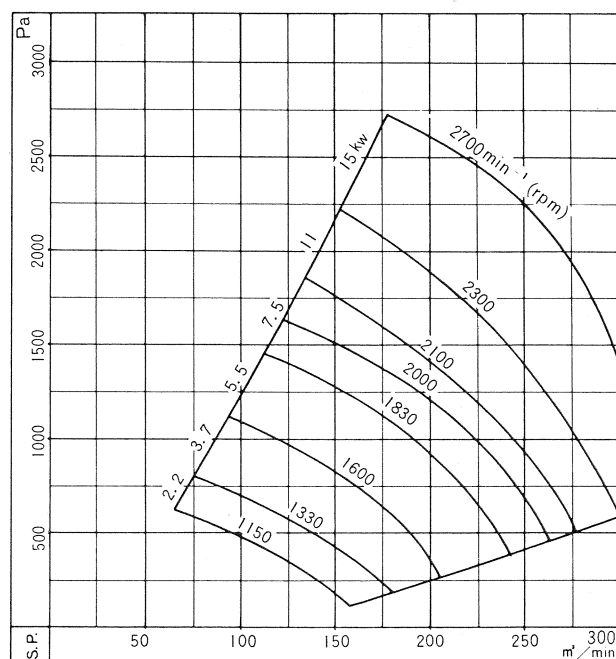

リミットロード送風機片吸込LS型

#4LS

#4 1/2LS

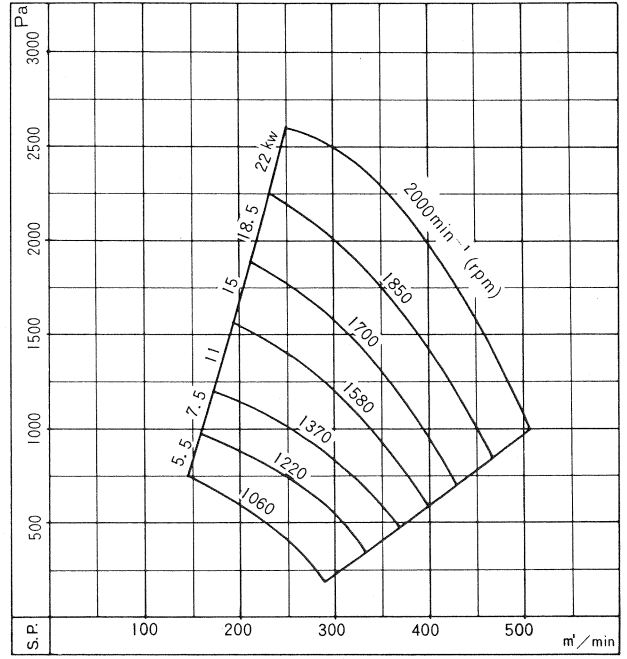
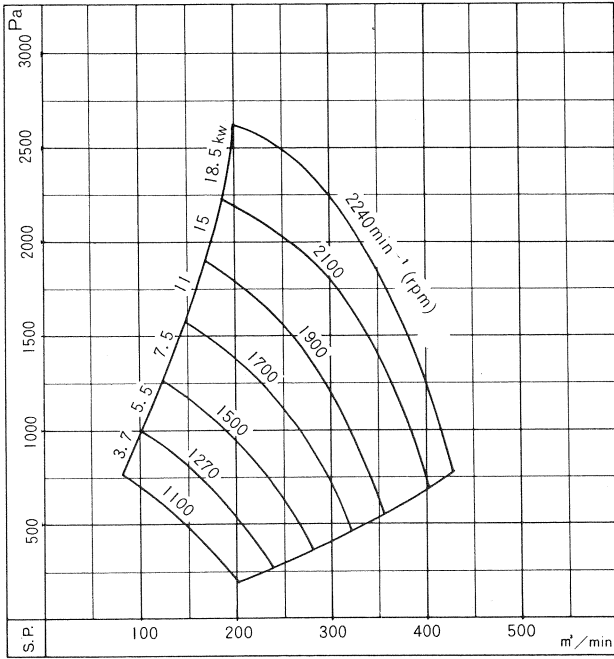

#5LS

#5 1/2LS

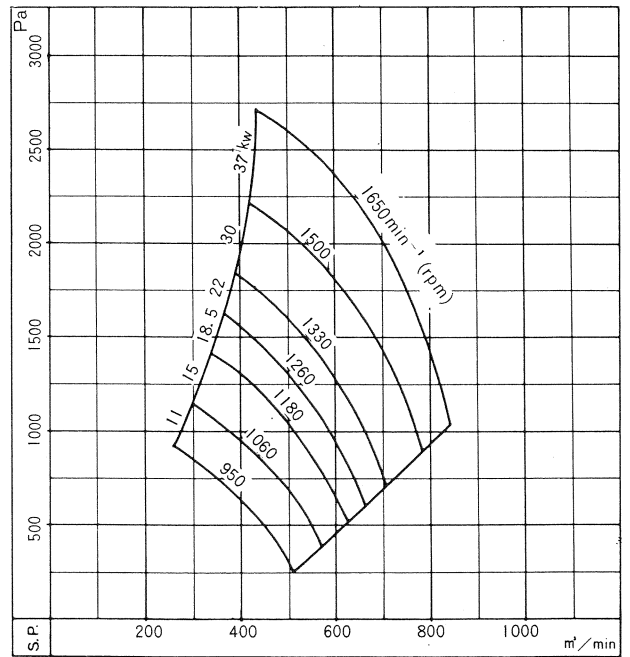
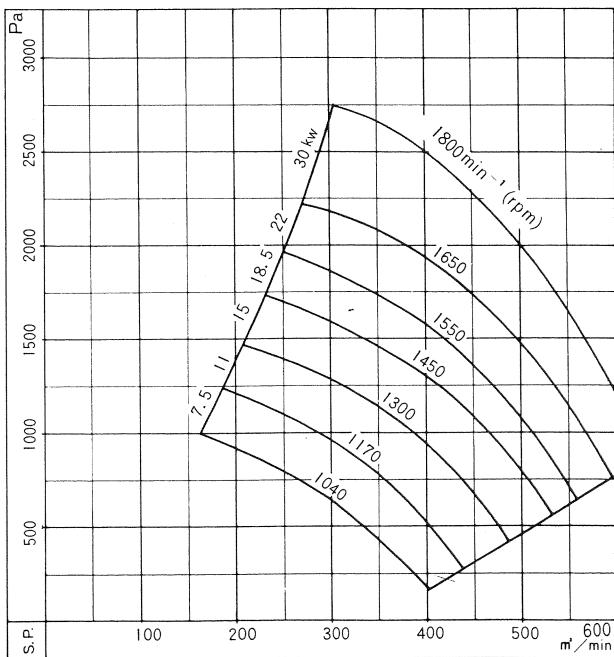

リミットロード送風機片吸込LS型

#6LS

#7LS

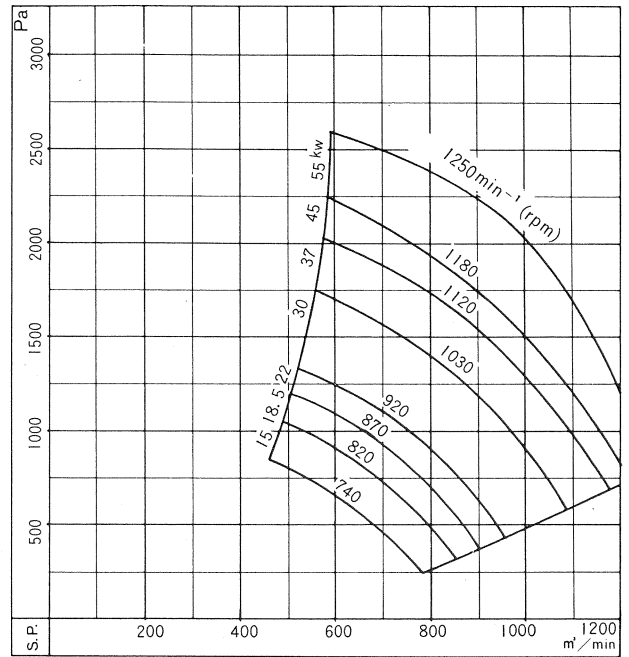
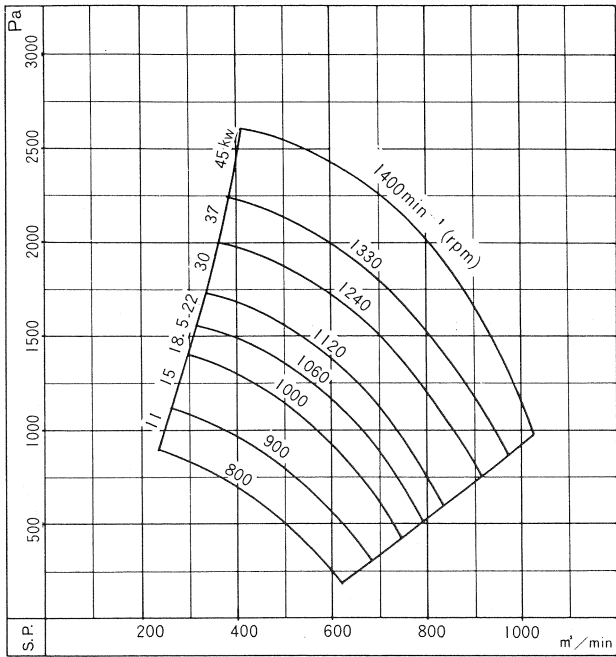

#8LS

#9LS

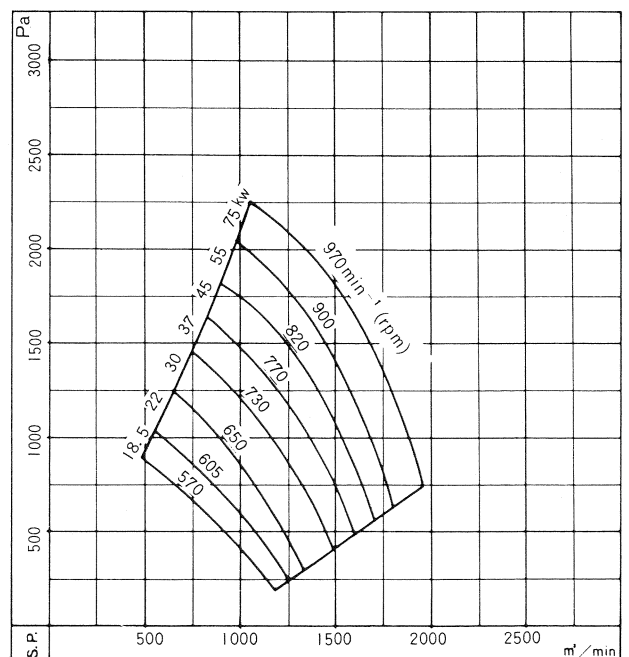
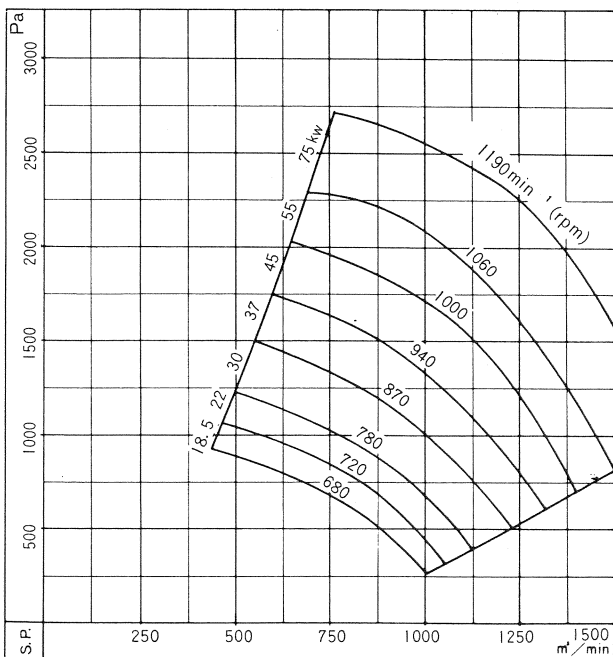

# 選定図

## リミットロード送風機片吸込LS型

### #10LS

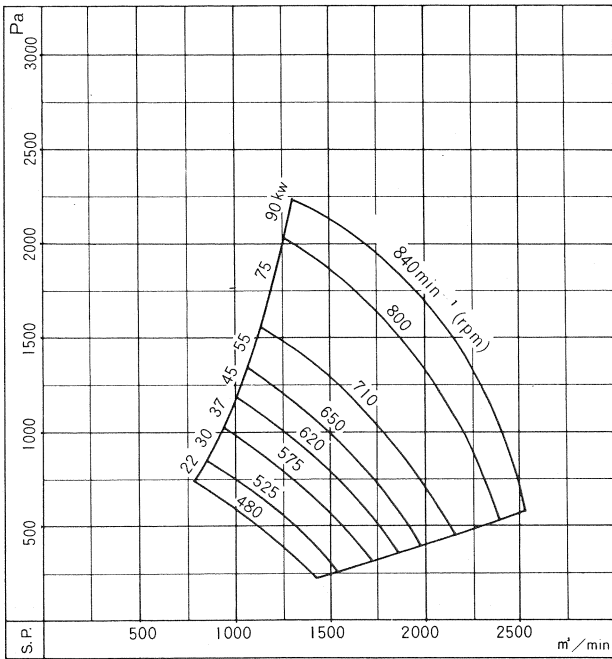

### #11LS

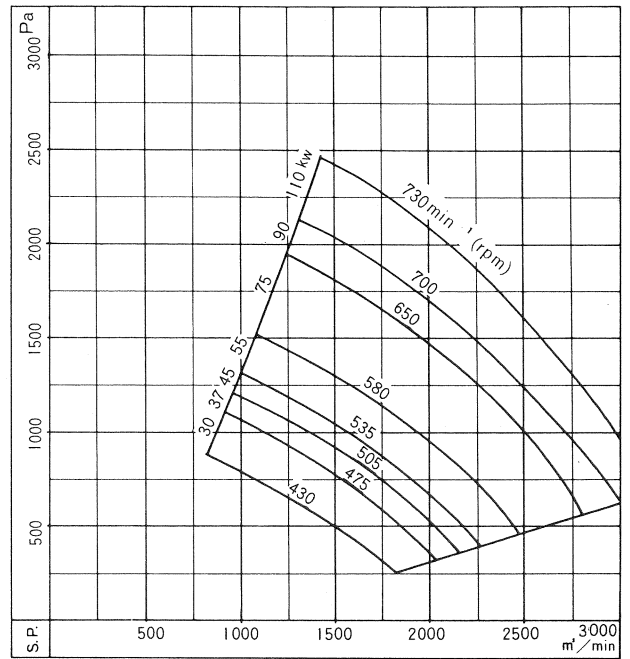

### #12LS

